

QD BOSS

PRODUCTS AND SOLUTIONS



Incombustible, Class A



Sound absorbing, NRC=0.9



ECO-friendly, Grade E1



Thermal insulation

-----Since 2008

Overseas Department

TEL/WhatsApp/Wechat/Line:

+8615192680619

+8618563932915

Email: info@qdboss.cn

Web: www.qdbossacoustic.com





About us

Qingdao Boss Flame Retardant Textile Materials Co, Ltd, established in 2008 is located in the beautiful seaside city - Qingdao, covering an area of 40000 square meters.





Qdboss has been committed to R & D, manufacturing and sales of building flame-retardant products and acoustic products, such as polyester fiber acoustic panel, Fabric wrapped acoustic panel, fiberglass acoustic ceiling, flame retardant fabric and etc. With high quality and competitive price, our products have been exported to more than 50 countries.

All of our products have passed national or international tests. We have obtained 7 national patents. We have faith in innovation, quality and efficiency. Warmly welcome all fields of friends to visit our company and negotiate business.



Glass Wool Ceiling



-  Incombustible, Class A
-  Sound absorbing,
-  ECO-friendly, Grade E1
-  Thermal insulation



Glass Wool Acoustic Ceiling	Glass wool, fiberglass felt, plaster edge
Fire(Glass)	A(non-combustible)
Environment	E
Acoustic	>0.96 (NRC)
Size	595x595x20mm,600*600*20mm,603x603x20mm 1200x600x20mm
Density	110KG/m3
Color	Black/white/personalized
Accessory	T&L type ceiling brackets
Features	Sound absorbent, thermal insulation, flame resistant, anti-bacteria, easy installation, environment friendly
Application	Cinemas, theatres, auditorium,exhibition galleries, studio rooms, gyms, and shopping malls



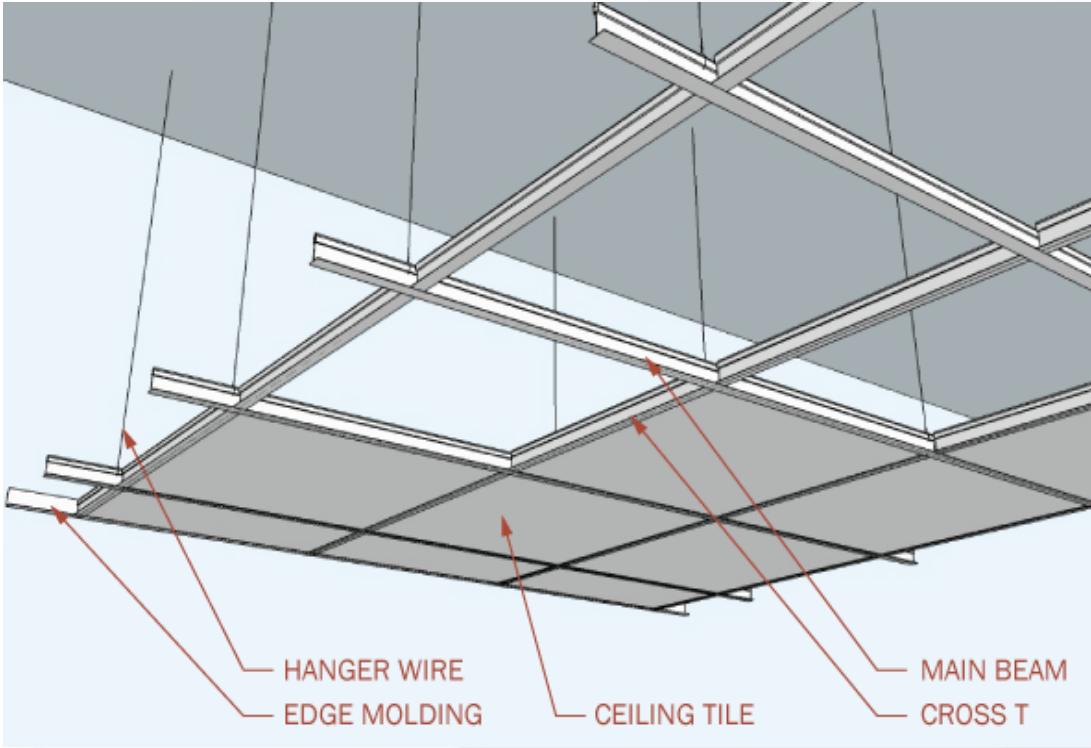

Ceiling System

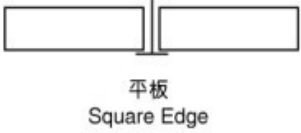
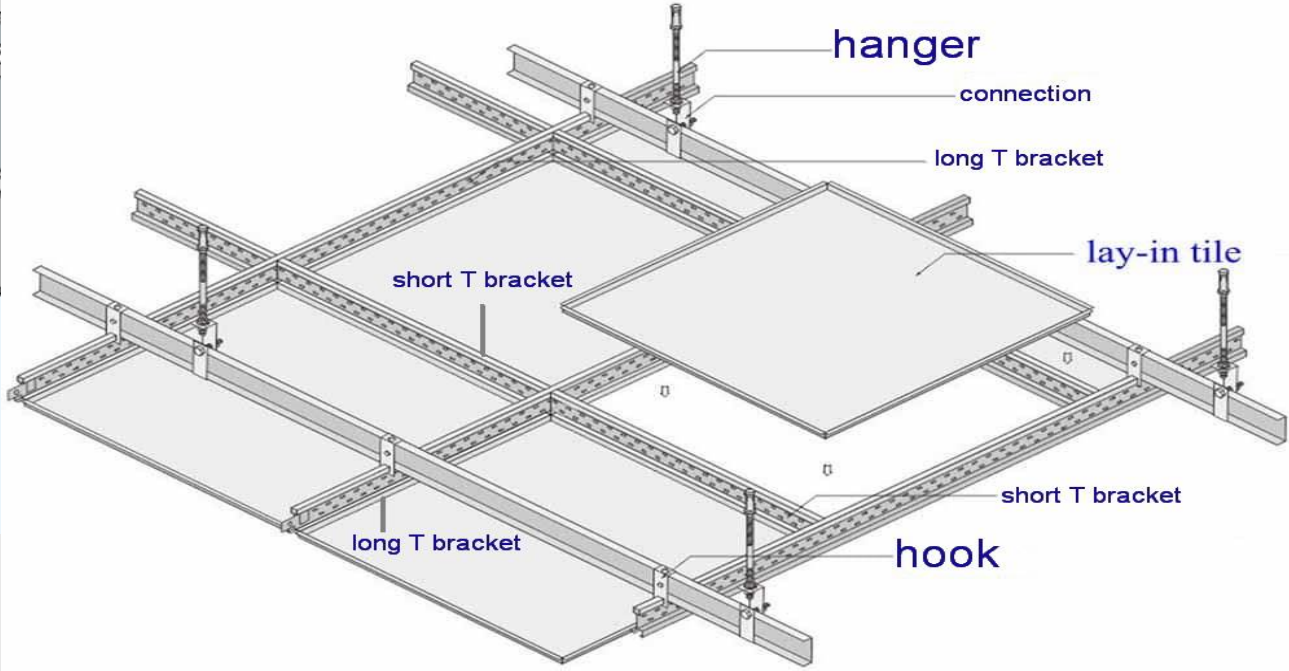

installing system



Fabric wrapped acoustic panel

-  Flame retardant, Class A/B
-  ECO-friendly, Grade E1
-  Thermal Insulation
-  Sound absorbing



Fabric wrapped acoustic panel	Glass wool, flame retardant fabric, fiberglass felt.
Fire(Glass)	A(non-combustible), B1
Environment	E
Acoustic	NRC>0.9
Size	1800mm*600mm*25mm,1200mm*600mm*25mm ,600mm*600*25mm,1800mm*600mm*50mm,1200mm*600mm*50mm ,600mm*600*50mm, others are personalized
Density	110kg/m3
Application	Widely used in all kinds of venues such as the court, cinema, concert hall, museum, exhibition hall, library, gallery, gymnasium, Auditorium, conference room, studio room, KTV, bar, work plant and home.
Features	Absorb low, middle and high frequency spectrum acoustic noises, fireproof, decorative, dozens of colors and patterns available, easy construction
Pattern	Color Guide is available please contact us

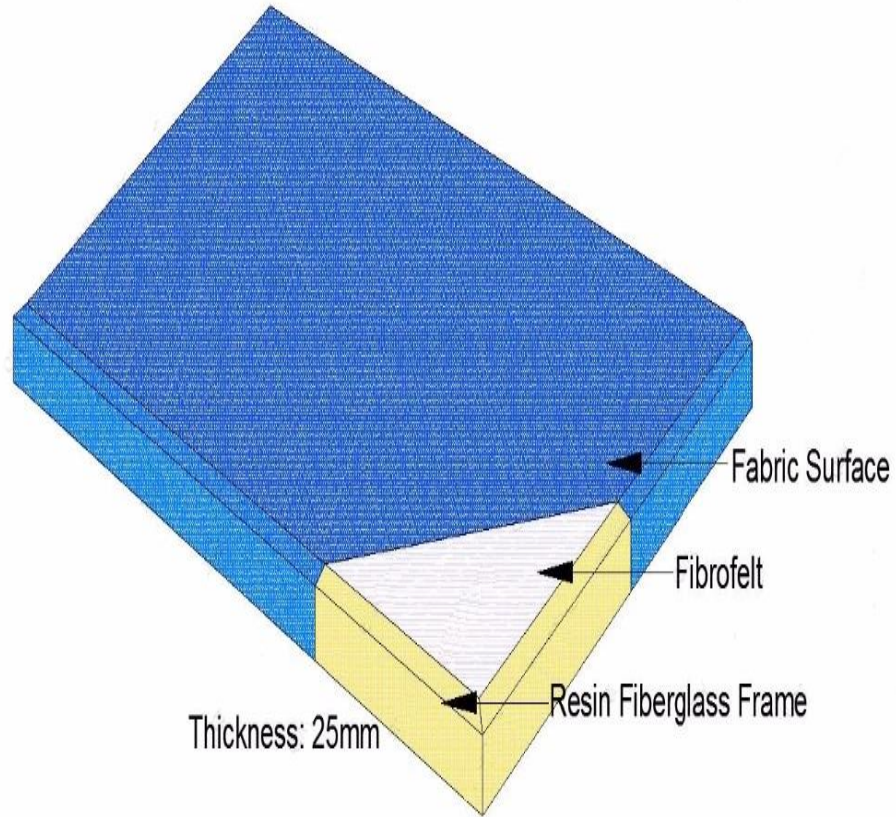

直角 Right angle

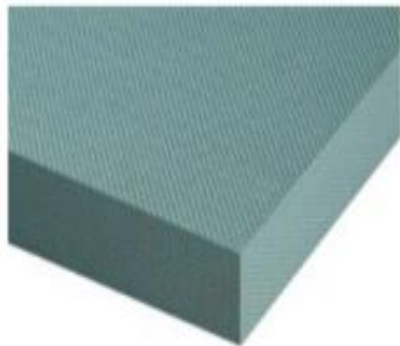

倒角 Chamfer

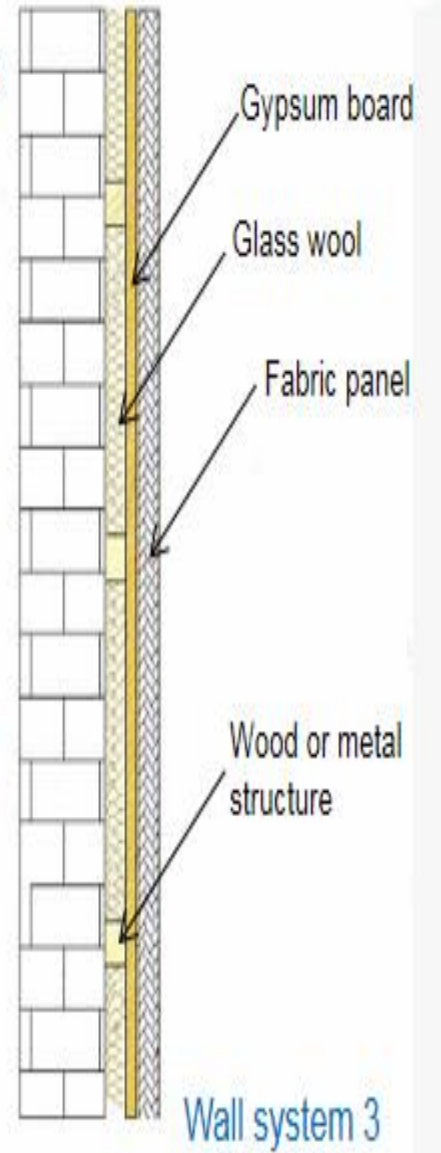
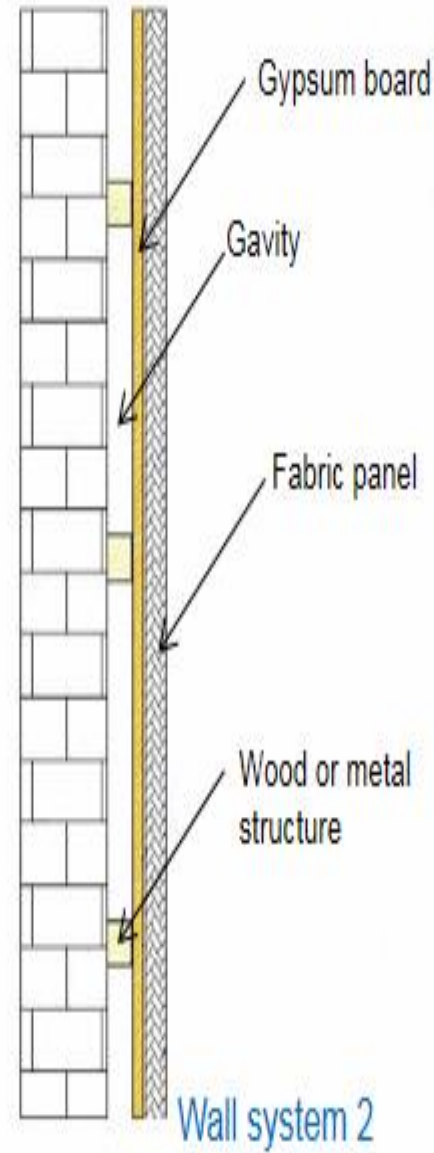
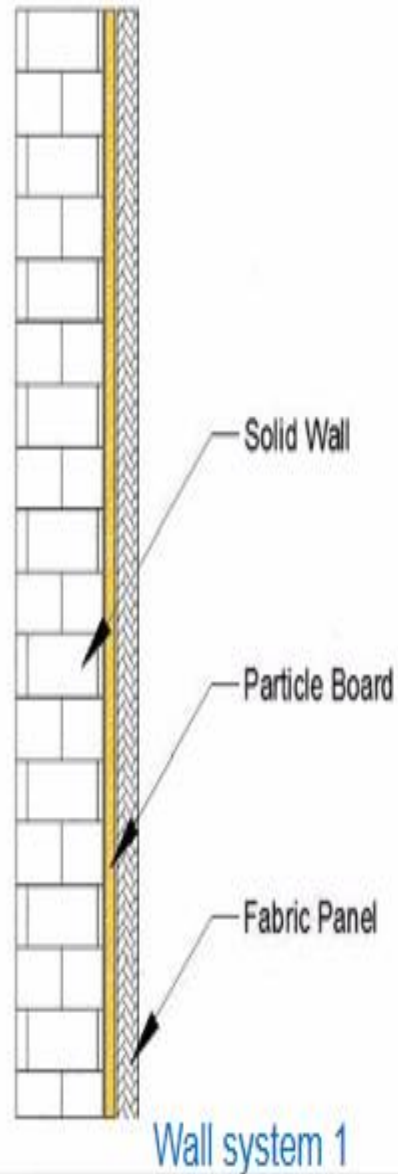
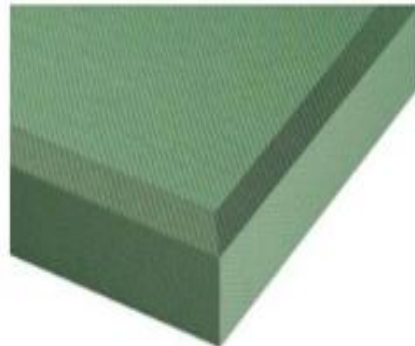

#Fabric wrapped acoustic panel#



Material: Glass wool panel wrapped by fabric
Size: 1200x600x25mm
1200x600x50mm
Color: According to the fabric brochure.
NRC: >0.9



Construct instruction

1. Draw sketch line on the smooth wall surface
2. Glue the back of the panel and then paste on the wall
3. Nail the panel from the edge with 45 degree



Polyester Fiber Acoustic Panel



PET Acoustic Panel	Polyester acoustic panel
Fire(Glass)	B
Environment	E
Acoustic	0.8 (NRC)
Size	2420x1220x9mm, 1200x600x9mm, 600x600x9mm, other thickness and size are personalized
Density	205KG/m ³ , 170kg/m ³ , 130kg/m ³
Color	44 colors
Accessory	
Features	Sound absorbent, thermal insulation, flame resistant, anti-bacteria, easy installation, environment friendly
Application	Ceiling, wall panel, Cinemas, theatres, auditorium, exhibition galleries, studio rooms, gyms, offices and shopping malls

Production Line



Seven Patents

The only production line in China which can produce the **permanent flame-retardant PET panel**

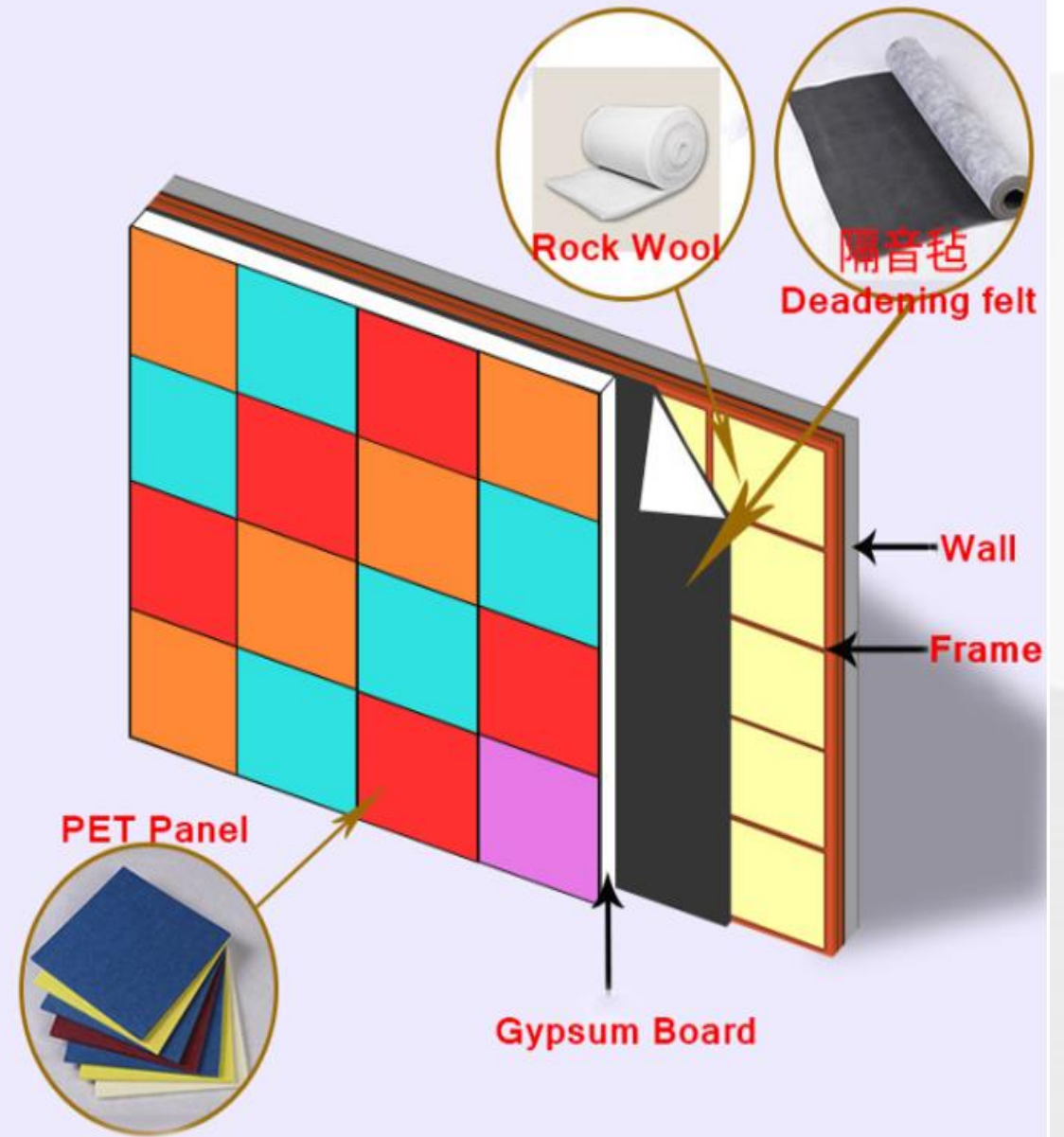

#Polyester Fiber Acoustic Panel#

Material: polyester fiber

Size: 2420x1220x9mm
2420x1220x12mm

Color: 44 colours are available

NRC:>0.8

Fire class: flame retardant

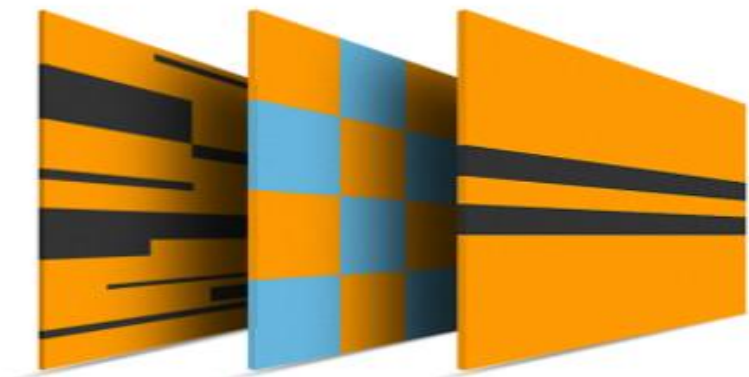
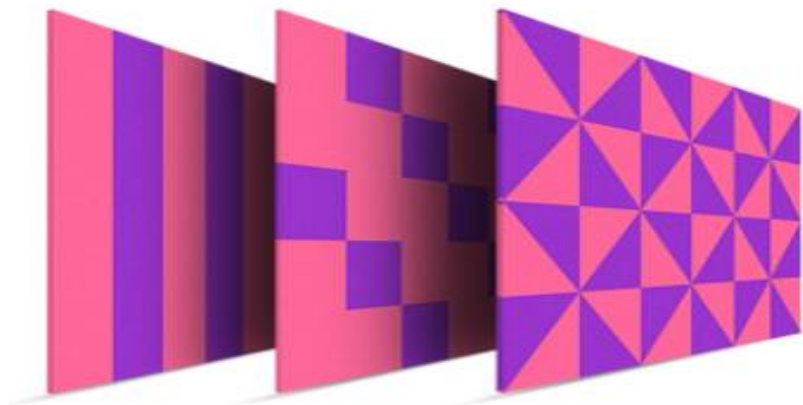
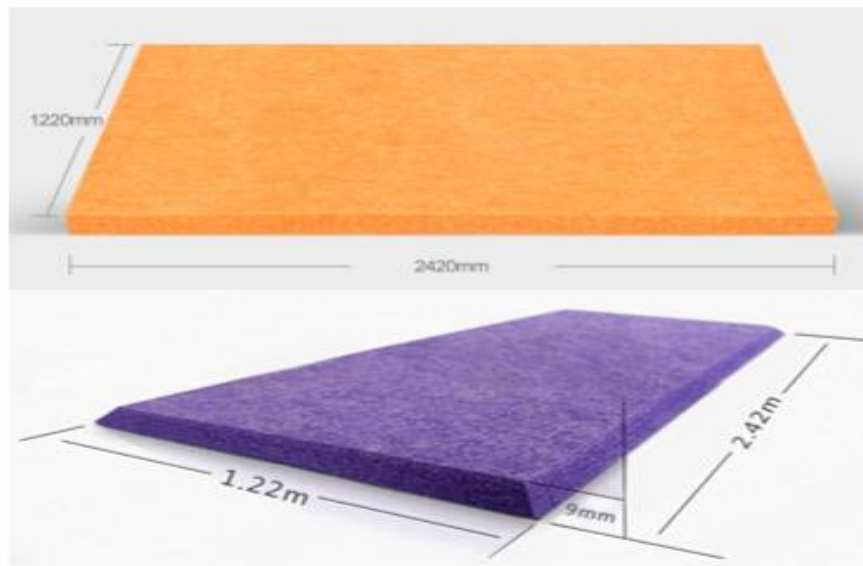

Construct instruction

1. Draw sketch line on the smooth wall surface
2. Glue or nail the panel on the wall



Wall frame filled with glass wool

Wall surface

Polyester fiber
acoustic panel

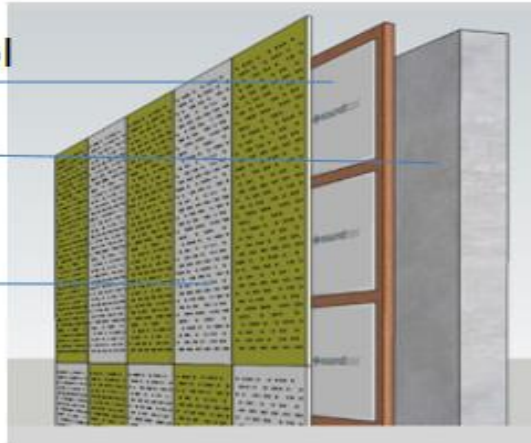

Air nail gun



Starry Sky Ceiling

Installation

Tools



Drilling Machine



Knife & Scissor



Glue



Nail Gun

Process

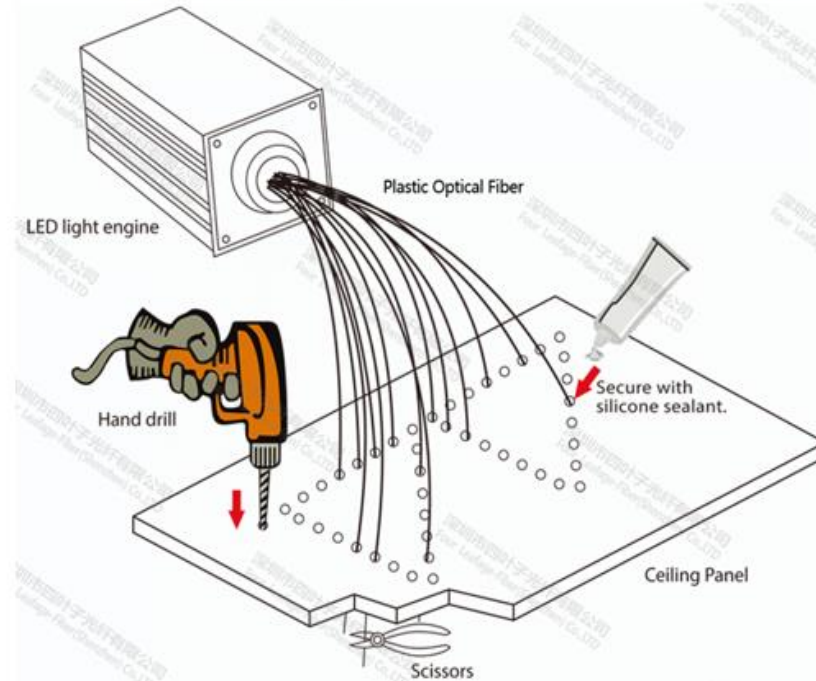

Stretched fabric with PVC frames system

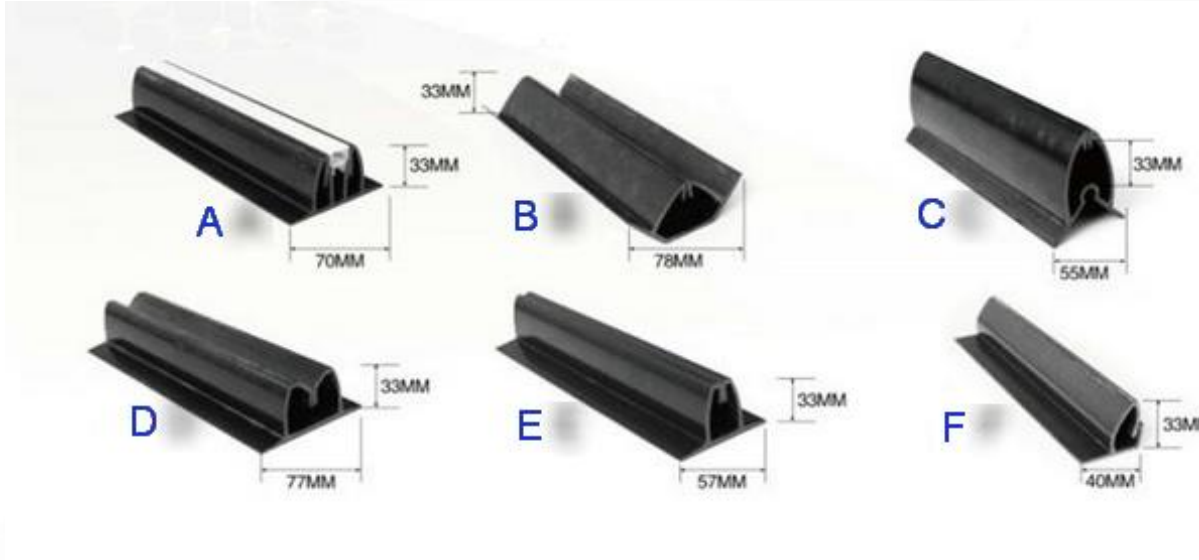

PVC frames	PVC
LED frame	33mm height,3m/pc
Concave frame	33mm height,3m/pc
Convex frame	33mm height,3m/pc
V-type frame	33mm height,3m/pc
Middle frame	33mm height,3m/pc
Side frame	33mm height,3m/pc

Fabric	Flame retardant fabric
Model	Z series/D series/A series
Environment	E
Width	1.5m
Weight	280-600g/m ²
Fire(Glass)	A, B



Wall carpet	Polyester fiber
Color	11
Environment	E
Width	1.5m
Weight	200-800g/m ²
Fire(Glass)	B



Glass Wool	Density
1200x600x25mm	90kg/m ³
1200x600x50mm	90kg/m ³
1200x600x50mm	32kg/m ³
Others	Personalized

Fabric cover glass wool with PVC frame



Fabric

PVC Frames

Wall Carpet



Glass wool panel

Construct instruction

1. Draw sketch line on the smooth wall surface
2. Cut the PVC frame and fabric according to your wall design(see A.0)
3. Nail the PVC frame on the wall (see A.1)
4. Fill in glass wool between the PVC frames(see A.2)
5. Use the special tool to cover and fix the fabric into the gap of the PVC frame(see A.3)



A.0



A.1



A.2



A.3

>>>>>>>

Left and right wall draft

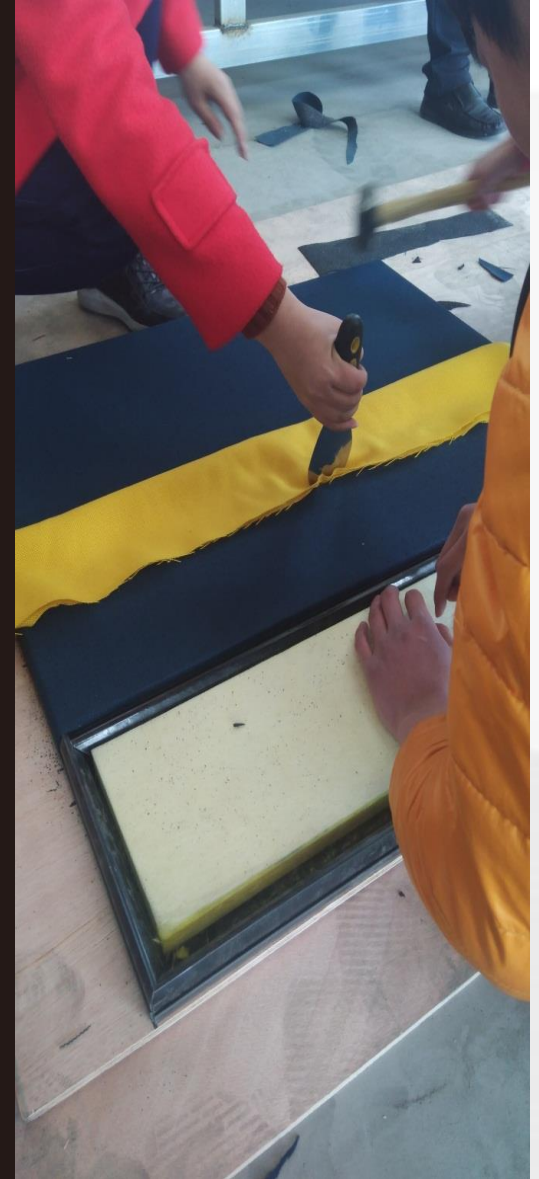
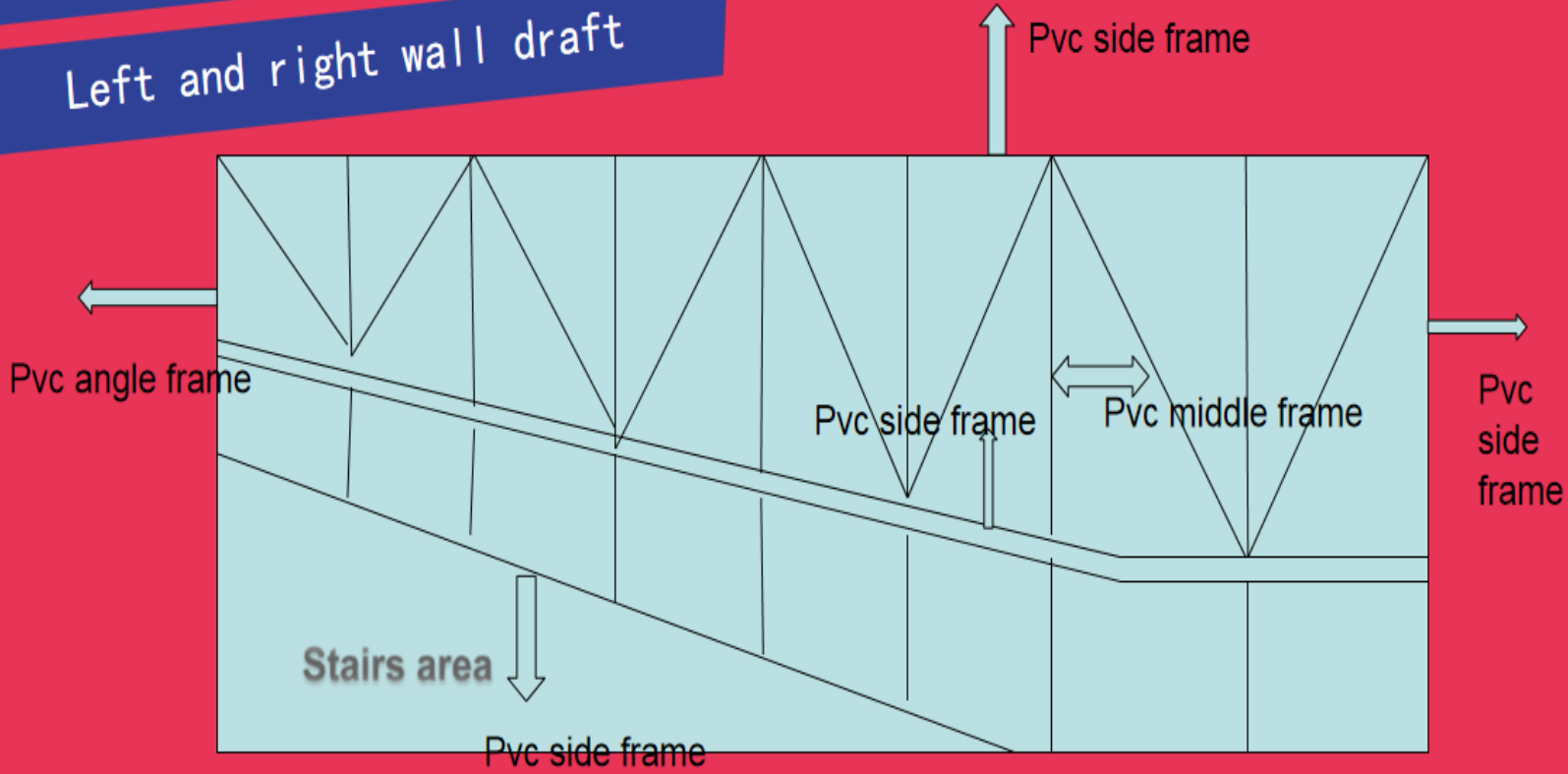



Fabric wrapped acoustic panel for screen	Glass wool, flame retardant non-woven fabric
Fire(Glass)	B1
Acoustic	NRC>0.95
Size	600mm*600mm*50mm ,1200mm*600*50mm
Density	32kg/m3
Application	Widely used on the wall behind the screen in cinema, concert hall, auditorium, studio room, theatre

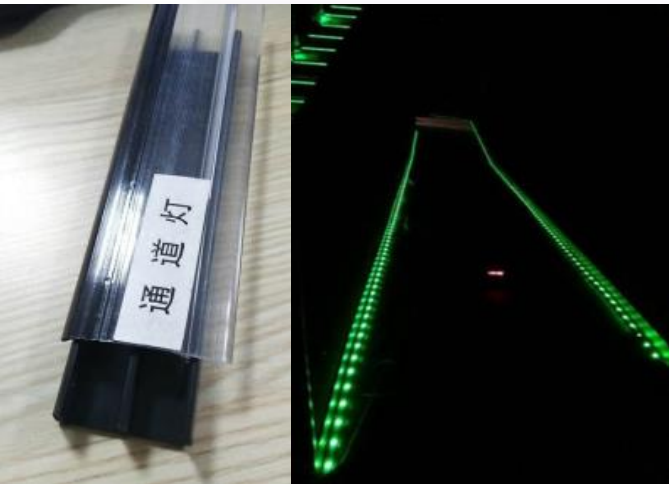

Aisle light

Aisle light	PVC, Transparent Cap, White Cap
Fire(Glass)	B
Color	Black frame, transparent or white cap
Size	2m per piece
Application	Cinema, theatre, auditorium
Accessories	LED strip, joint, corner connection, bolt
Led color	White, Blue,Green,Yellow,Red



Model ST02



Model ST04

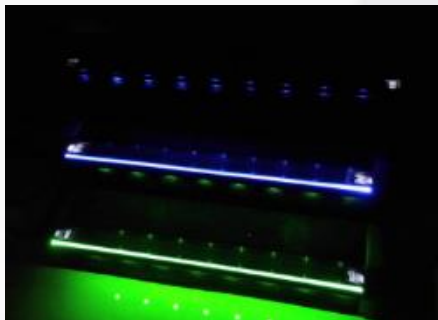

Step light	Alluminium Alloy, ABS
Fire(Glass)	A
Color	Black or personalized
Size	6m, 4m per piece
Light groove	Upward, downward, upward and downward
Application	Cinema, theatre, auditorium
Features	Wearproof, antislip, fireproof, rigid, non-deformation
Accessories	ABS end cap, row number, LED strip, LED fiber, joint, row number LED
LED color	White, Blue, Green, Yellow, Red, Orange
LED style	Spot light, Liner Light



PVC Stair protector

PVC Stair protector	PVC
Fire(Glass)	B
Color	Black
Size	2m per piece
Application	To protect the step angle under the chair

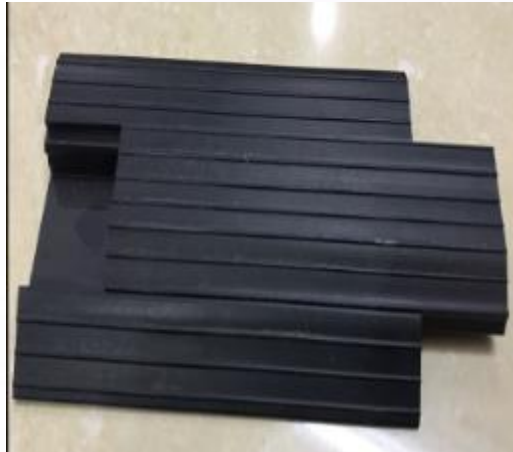

PVC Wire Track for step light

Wire Track	PVC
Fire(Glass)	B
Color	Black frame, black cap
Size	2m per piece
Application	Wire box of step light





Carpet

Model 1	Polyester carpet
Model 2	Nylon carpet
Model 3	80% Nylon 20% wool carpet
Flame resistant	Available
Weight	800g/m ² , 1000g/m ² , 1200g/m ² etc
Thickness	6mm, 7mm
Application	Widely used in all kinds of venues such as the court, cinema, concert hall, museum, exhibition hall, library, gallery, gymnasium, Auditorium, conference room, studio room, KTV, bar, work plant and home.
Features	Absorb low frequency spectrum acoustic noises, fireproof, decorative, easy construction
Pattern	Personalized
Width	4m per roll

Power Transformer



Material	Metal
Model 1	220V/110V-12V
Model 2	220V/110V-5V
Package	Carton
Weight	About 1kg per set
Application	24V, 5V Led on ceiling, wall and floor.

AC/IN alternating current
DC/OUT direct current
COM -----"-"
+V -----"+"
L -----"live line"
N-----"null line"

OUR ADVANTAGES

WHY CHOOSE US

OEM/ODM

10+ years experience in flame retardant & acoustic product

FIRST-CLASS TEAM

World's leading technology
Seven national patents

HIGH QUALITY

Quality Test - SGS, ASTM E84,
CA117, BS5852, AS1530, etc.

FACTORY PRICE

We're professional manufacturer
can offer you a competitive price.

CERTIFICATE

VIEW MORE



Exhibition 2018

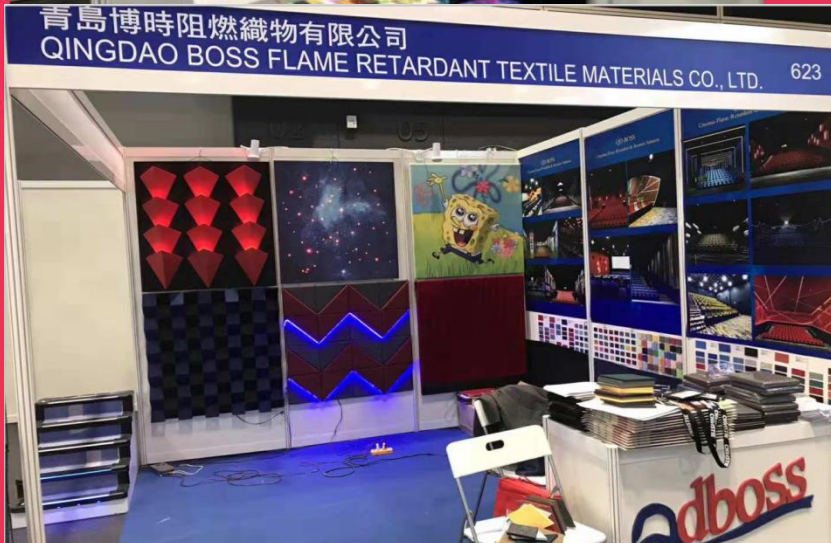

Date	Location	Show
24-26th April	Las Vegas, USA	CinemaCon 2018
11st-14th June	Barcelona, Spain	CineEurope
22-25th August	Beijing, China	BIRTV
28-29th August	Mumbai, India	Big CineExp
18-21st Sep	St Petersburg, Russia	Kino Expo
11-13rd Dec	Hongkong, China	CineAsia

Our Exhibitions



Customer Visit in Southeast Asia



Famous Cinema Chain in Indonesia



Famous Cinema Chain in Thailand



Big Contractor in the Philippines



Construction Factory in Malaysia



Architecture Company in Vietnam



Designer and Contractor in Vietnam

Partners

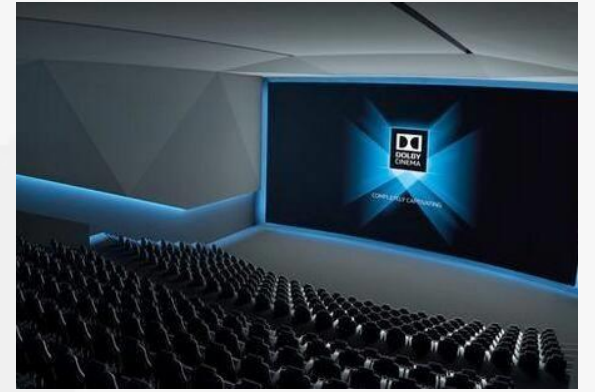

Wanda Cinemas



Emperor ua cinemas

Jackie Chan Cinema

Dadi Cinema

Partners



Hengdian Cinemas



Bingao Cinemas



Oscar

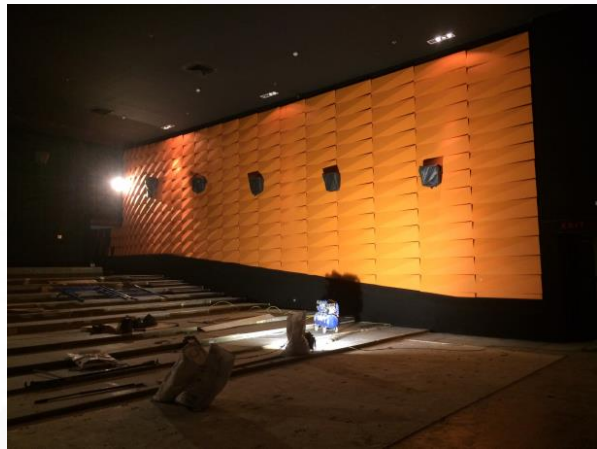

MVP Movie



OSR Cinemas



Red Radiance

Partners



Bona



Jinyi Cinemas



HBC



Bestar Cinema



Suning Cinema



Taihoe Cinema

Partners



Omnijoi International Cinema



CGV



Water Cube
Beijing National Aquatics Center



Alibaba-Pictures



Evergrande Cinemas

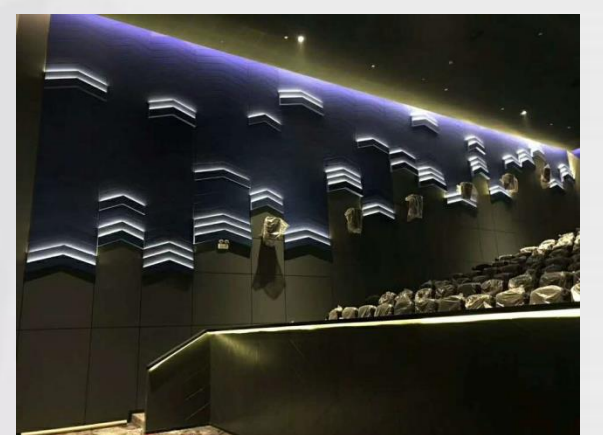

—END—
Thank you!

-----Since 2008



Overseas Department

TEL/WhatsApp/Wechat/Line:

+8615192680619

+8618563932915

Email: info@qdboss.cn

Web: www.qdbossacoustic.com